

Packaged Air-Conditioners INDOOR UNIT

SEZ-M25,M35,M50,M60,M71DA2 SEZ-M25,M35,M50,M60,M71DAL2

OPERATION MANUAL	FOR USER	English
BEDIENUNGSHANDBUCH	FÜR BENUTZER	Deutsch
MANUEL D'UTILISATION	POUR L'UTILISATEUR	Français
BEDIENINGSHANDLEIDING	VOOR DE GEBRUIKER	Nederlands
MANUAL DE INSTRUCCIONES	PARA EL USUARIO	Español
ISTRUZIONI DI FUNZIONAMENTO	PER L'UTENTE	Italiano
ΕΓΧΕΙΡΙΔΙΟ ΟΔΗΓΙΩΝ ΧΡΗΣΕΩΣ	ΓΙΑ ΤΟΝ ΧΡΗΣΤΗ	Ελληνικό
MANUAL DE OPERAÇÃO	PARA O UTILIZADOR	Português
DRIFTSMANUAL	TIL BRUGER	Dansk
DRIFTSMANUAL	FÖR ANVÄNDAREN	Svenska
İŞLETME ELKİTABI	KULLANICI İÇİN	Türkçe
РУКОВОДСТВО ПО ЭКСПЛУАТАЦИИ	ДЛЯ ПОЛЬЗОВАТЕЛЯ	Русский
ПОСІБНИК З ЕКСПЛУАТАЦІЇ	ДЛЯ КОРИСТУВАЧА	Українська
РЪКОВОДСТВО ЗА ЕКСПЛОАТАЦИЯ	ЗА ПОТРЕБИТЕЛЯ	Български
INSTRUKCJA OBSŁUGI	INFORMACJA DLA UŻYTKOWNIKA	Polski
BRUKSANVISNING	FOR BRUKER	Norsk
KÄYTTÖOPAS	KÄYTTÄJÄLLE	Suomi
PROVOZNI PŘÍRUČKA	PRO UŽIVATELE	Čeština
NÁVOD NA OBSLUHU	PRE POUŽÍVATEĽA	Slovenčina
HASZNÁLATI KÉZIKÖNYV	A FELHASZNÁLÓNAK	Magyar
NAVODILA ZA UPORABO	ZA UPORABNIKA	Slovenščina
MANUAL DE UTILIZARE	PENTRU UTILIZATOR	Română
KASUTUSJUHEND	KASUTAJALE	Eesti
LIETOŠANAS ROKASGRĀMATA	LIETOTĀJIEM	Latviski
NAUDOJIMO VADOVAS	SKIRTA NAUDOTOJUI	Lietuviškai
PRIRUČNIK ZA RUKOVANJE	ZA KORISNIKA	Hrvatski
UPUTSTVO ZA RUKOVANJE	ZA KORISNIKA	Srpski

Contents

1. Safety Precautions	2	5. Emergency Operation for Wireless Remote-controller (SEZ-M-DAL2 series)	9
2. Parts Names	3	6. Care and Cleaning	9
3. Operation	6	7. Trouble Shooting	10
4. Timer	9	8. Installation, relocation and inspection	11
		9. Specifications	12

Note



Fig. 1

This symbol mark is for EU countries only.

This symbol mark is according to the directive 2012/19/EU Article 14 Information for users and Annex IX, and/or to the directive 2006/66/EC Article 20 Information for end-users and Annex II.

Your MITSUBISHI ELECTRIC product is designed and manufactured with high quality materials and components which can be recycled and/or reused. This symbol means that electrical and electronic equipment, batteries and accumulators, at their end-of-life, should be disposed of separately from your household waste. If a chemical symbol is printed beneath the symbol (Fig. 1), this chemical symbol means that the battery or accumulator contains a heavy metal at a certain concentration.

This will be indicated as follows: Hg: mercury (0.0005%), Cd: cadmium (0.002%), Pb: lead (0.004%)

In the European Union there are separate collection systems for used electrical and electronic products, batteries and accumulators. Please, dispose of this equipment, batteries and accumulators correctly at your local community waste collection/recycling centre. Please, help us to conserve the environment we live in!

Note:
The phrase "Wired remote controller" in this operation manual refers only to the PAR-41MAA. If you need any information for the other remote controller, please refer to the instruction book included in this box.

1. Safety Precautions

- ▶ Before installing the unit, make sure you read all the "Safety Precautions".
- ▶ The "Safety Precautions" provide very important points regarding safety. Make sure you follow them.
- ▶ Please report to or take consent by the supply authority before connection to the system.

MEANINGS OF SYMBOLS ON THE UNIT

	WARNING (Risk of fire)	This symbol is only for R32 refrigerant. The type of the refrigerant used is written on the nameplate on the outdoor unit. R32 refrigerant is flammable. If the refrigerant leaks, or comes in contact with fire or parts that generate heat, it may create harmful gas and pose a risk of fire.
		Read the OPERATION MANUAL carefully before operation.
		Service personnel are required to carefully read the OPERATION MANUAL and INSTALLATION MANUAL before operation.
		Further information is available in the OPERATION MANUAL, INSTALLATION MANUAL, and the like.

Symbols used in the text

Warning:

Describes precautions that should be observed to prevent danger of injury or death to the user.

Caution:

Describes precautions that should be observed to prevent damage to the unit.

Warning:

- These appliances are not accessible to the general public.
- The unit must not be installed by the user. Ask the dealer or an authorized company to install the unit. If the unit is installed improperly, water leakage, electric shock or fire may result.
- Do not stand on, or place any items on the unit.
- Do not splash water over the unit and do not touch the unit with wet hands. An electric shock may result.
- Do not spray combustible gas close to the unit. Fire may result.
- Do not place a gas heater or any other open-flame appliance where it will be exposed to the air discharged from the unit. Incomplete combustion may result.
- Do not remove the front panel or the fan guard from the outdoor unit when it is running.
- When you notice exceptionally abnormal noise or vibration, stop operation, turn off the power switch, and contact your dealer.
- Never insert fingers, sticks etc. into the intakes or outlets.
- If you detect odd smells, stop using the unit, turn off the power switch and consult your dealer. Otherwise, a breakdown, electric

Symbols used in the illustrations

: Indicates a part which must be grounded.

shock or fire may result.

- This air conditioner is NOT intended for use by children or infirm persons without supervision.
- Young children must be supervised to ensure that they do not play with the air conditioner.
- If the refrigeration gas blows out or leaks, stop the operation of the air conditioner, thoroughly ventilate the room, and contact your dealer.
- When installing, relocating, or servicing the air conditioner, use only the specified refrigerant written on the outdoor unit to charge the refrigerant lines. Do not mix the refrigerant with any other refrigerant, and do not allow air to remain in the lines.
 - If air is mixed with the refrigerant, then it may cause abnormal high pressure in the refrigerant lines, resulting in an explosion and other hazards.
 - The use of any refrigerant other than that specified for the system will cause mechanical failure, system malfunction, or unit breakdown. In the worst case, this could lead to a serious impediment to securing product safety.
 - It may also be in violation of applicable laws.
 - MITSUBISHI ELECTRIC CORPORATION cannot be held

1. Safety Precautions

- responsible for malfunctions or accidents resulting from the use of the wrong type of refrigerant.
- This indoor unit should be installed in a room which is equal to or larger than the floor space specified in the outdoor unit installation manual. Refer to the outdoor unit installation manual.**
- Only use means recommended by the manufacturer to accelerate the defrosting process or to clean.**

- This indoor unit shall be stored in a room that has no continuously-operating ignition device such as open flame, gas appliance, or electrical heater.**
- Do not pierce a hole in or burn this indoor unit or refrigerant lines.**
- Be aware that the refrigerant may be odour-free.**

⚠ Caution:

- Do not use any sharp object to push the buttons, as this may damage the remote controller.**
- Never block or cover the indoor or outdoor unit's intakes or outlets.**

Disposing of the unit

When you need to dispose of the unit, consult your dealer.

2. Parts Names

■ Indoor Unit

	SEZ-M·DA2 SEZ-M·DAL2
Fan steps	3 steps
Vane	—
Louver	—
Filter	Normal
Filter cleaning indication	—

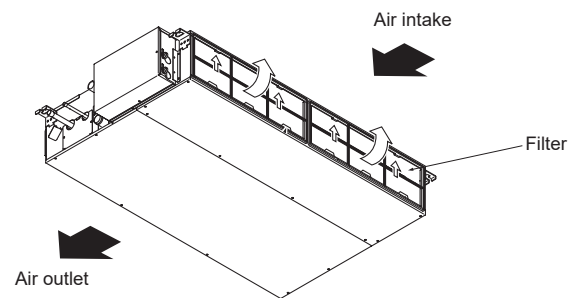

2. Parts Names

■ Wired Remote Controller

Controller interface

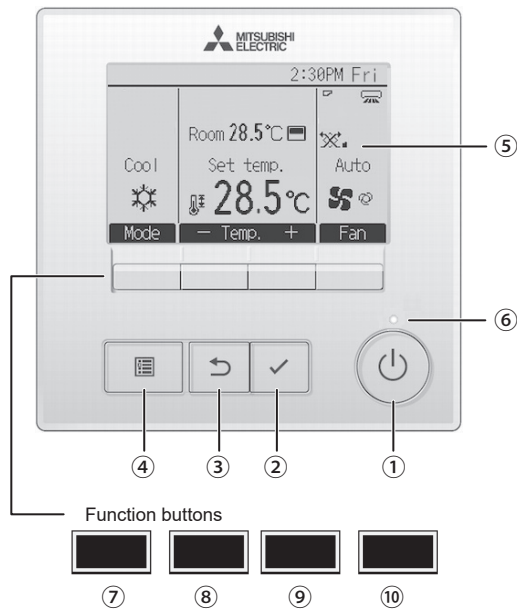

The functions of the function buttons change depending on the screen.

Refer to the button function guide that appears at the bottom of the LCD for the functions they serve on a given screen.

When the system is centrally controlled, the button function guide that corresponds to the locked button will not appear.

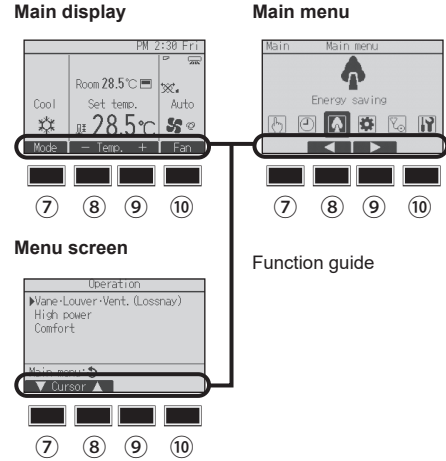

① [ON/OFF] button

Press to turn ON/OFF the indoor unit.

② [SELECT] button

Press to save the setting.

③ [RETURN] button

Press to return to the previous screen.

④ [MENU] button

Press to bring up the Main menu.

⑤ Backlit LCD

Operation settings will appear.

When the backlight is off, pressing any button turns the backlight on and it will stay lit for a certain period of time depending on the screen.

When the backlight is off, pressing any button turns the backlight on and does not perform its function. (except for the [ON/OFF] button)

⑥ ON/OFF lamp

This lamp lights up in green while the unit is in operation. It blinks while the remote controller is starting up or when there is an error.

⑦ Function button [F1]

Main display: Press to change the operation mode.

Main menu: Press to move the cursor down.

⑧ Function button [F2]

Main display: Press to decrease temperature.

Main menu: Press to move the cursor up.

⑨ Function button [F3]

Main display: Press to increase temperature.

Main menu: Press to go to the previous page.

⑩ Function button [F4]

Main display: Press to change the fan speed.

Main menu: Press to go to the next page.

2. Parts Names

Display

The main display can be displayed in two different modes: "Full" and "Basic". The factory setting is "Full". To switch to the "Basic" mode, change the setting on the Main display setting. (Refer to operation manual included with remote controller.)

<Full mode>

* All icons are displayed for explanation.

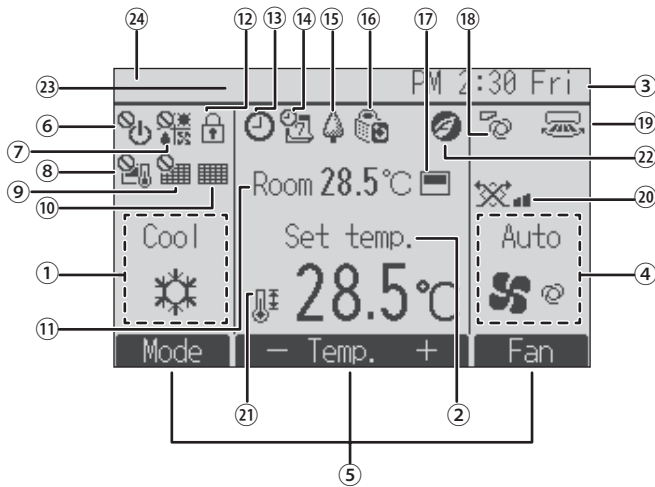

<Basic mode>

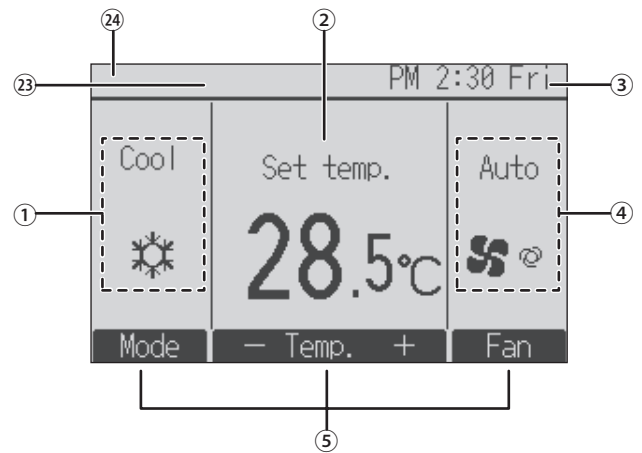

① Operation mode

Indoor unit operation mode appears here.

② Preset temperature

Preset temperature appears here.

③ Clock (See the Installation Manual.)

Current time appears here.

④ Fan speed

Fan speed setting appears here.

⑤ Button function guide

Functions of the corresponding buttons appear here.



Appears when the ON/OFF operation is centrally controlled.



Appears when the operation mode is centrally controlled.



Appears when the preset temperature is centrally controlled.



Appears when the filter reset function is centrally controlled.



Indicates when filter needs maintenance.

⑪ Room temperature (See the Installation Manual.)

Current room temperature appears here.



Appears when the buttons are locked.



Appears when the On/Off timer, Night setback, or Auto-off timer function is enabled.

 appears when the timer is disabled by the centralized control system.



Appears when the Weekly timer is enabled.



Appears while the units are operated in the energy-save mode. (Will not appear on some models of indoor units)



Appears while the outdoor units are operated in the silent mode.



Appears when the built-in thermistor on the remote controller is activated to monitor the room temperature (⑪).



Indicates the vane setting.



Indicates the louver setting.



Indicates the ventilation setting.



Appears when the preset temperature range is restricted.



Appears when an energy-saving operation is performed using a "3D i-See sensor" function.

②③ Centrally controlled

Appears for a certain period of time when a centrally-controlled item is operated.

②④ Preliminary error display

An error code appears during the preliminary error.

Most settings (except ON/OFF, mode, fan speed, temperature) can be made from the Menu screen.

2. Parts Names

Outdoor unit

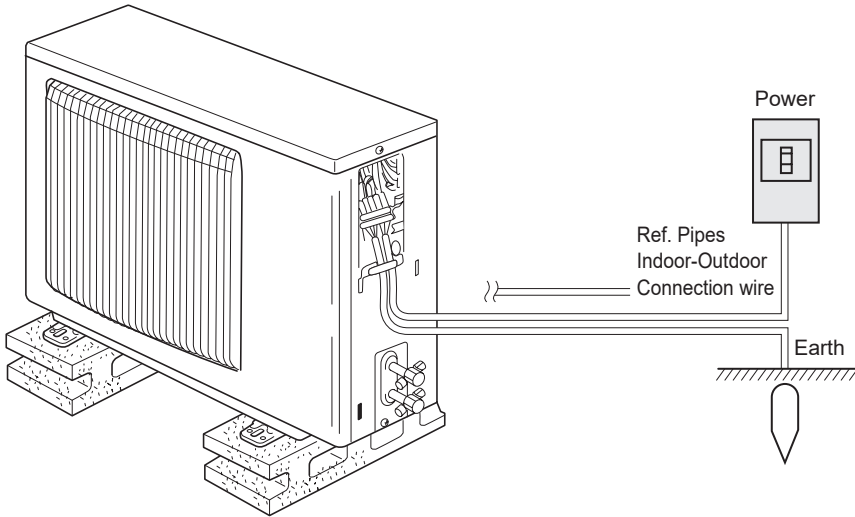

3. Operation

■ About the operation method, refer to the operation manual that comes with each remote controller.

3.1. Turning ON/OFF

3.1.1. For wired remote controller

[ON]

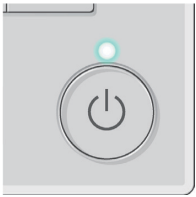

Press the [ON/OFF] button. The ON/OFF lamp will light up in green, and the operation will start. When "LED lighting" is set to "No," the ON/OFF lamp will not light up.
* Refer to the installation manual of wired remote controller.

[OFF]



Press the [ON/OFF] button again. The ON/OFF lamp will come off, and the operation will stop.

Note:

Even if you press the ON/OFF button immediately after shutting down the operation is progress, the air conditioner will not start for about three minutes. This is to prevent the internal components from being damaged.

■ Operation status memory

	Remote controller setting
Operation mode	Operation mode before the power was turned off
Preset temperature	Preset temperature before the power was turned off
Fan speed	Fan speed before the power was turned off

■ Settable preset temperature range

Operation mode	Preset temperature range
Cool/Dry	19 – 30 °C
Heat	17 – 28 °C
Auto	19 – 28 °C
Fan/Ventilation	Not settable

3.2. Mode select

3.2.1. For wired remote controller

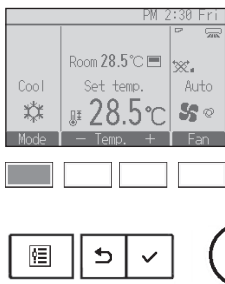

Each pressing of the [F1] button cycles through the following operation modes. Select the desired operation mode.

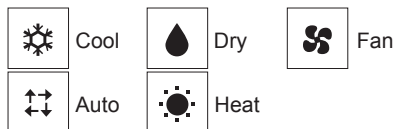

• Operation modes that are not available to the connected indoor unit models will not appear on the display.

What the blinking mode icon means

The mode icon will blink when other indoor units in the same refrigerant system (connected to the same outdoor unit) are already operated in a different mode. In this case, the rest of the unit in the same group can only be operated in the same mode.

3.2.2. For wireless remote controller

■ Press the operation mode (□❄️💧🌀☀️) button ② and select the operation mode ②.

- ❄️ Cooling mode
- 💧 Drying mode
- 🌀 Fan mode
- ☀️ Heating mode
- Automatic (cooling/heating) mode
- 🌀 Ventilation mode

Only indicated on the following condition
Wired remote controller used
LOSSNAY connected

3. Operation

Information for multi system air conditioner (Outdoor unit: MXZ series)

- ▶ **Multi system air conditioner (Outdoor unit: MXZ series) can connect two or more indoor units with one outdoor unit. According to the capacity, two or more units can operate simultaneously.**
- When you try to operate two or more indoor units with one outdoor unit simultaneously, one for the cooling and the other for heating, the operation mode of the indoor unit that operates earlier is selected. The other indoor units that will start the operation later cannot operate, indicating an operation state in flashing.
- In this case, please set all the indoor units to the same operation mode.
- There might be a case that the indoor unit, which is operating in (AUTO) mode. Cannot change over to the operating mode (COOL ↔ HEAT) and becomes a state of standby.
- When indoor unit starts the operation while the defrosting of outdoor unit is being done, it takes a few minutes (max. about 15 minutes) to blow out the warm air.
- In the heating operation, though indoor unit that does not operate may get warm or the sound of refrigerant flowing may be heard, they are not malfunction. The reason is that the refrigerant continuously flows into it.

Automatic operation

- According to a set temperature, cooling operation starts if the room temperature is too hot and heating operation starts if the room temperature is too cold.
- During automatic operation, if the room temperature changes and remains 2 °C or more above the set temperature for 15 minutes, the air conditioner switches to cooling mode. In the same way, if the room temperature remains 2 °C or more below the set temperature for 15 minutes, the air conditioner switches to heating mode.

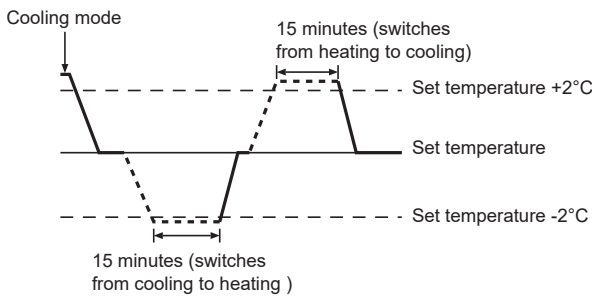

- Because the room temperature is automatically adjusted in order to maintain a fixed effective temperature, cooling operation is performed a few degrees warmer and heating operation is performed a few degrees cooler than the set room temperature once the temperature is reached (automatic energy-saving operation).

3.3. Temperature setting

3.3.1. For wired remote controller

<Cool, Dry, Heat, and Auto>

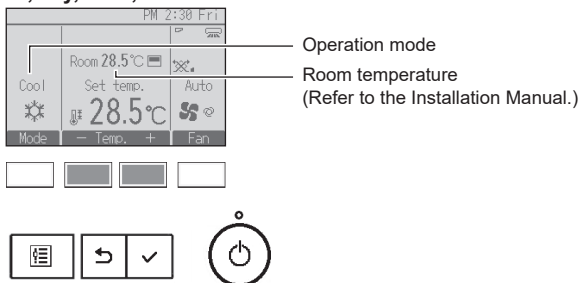

Press the [F2] button to decrease the preset temperature, and press the [F3] button to increase.

- Refer to the table on page 6 for the settable temperature range for different operation modes.
- Preset temperature range cannot be set for Fan/Ventilation operation.
- Preset temperature will be displayed either in Centigrade in 0.5- or 1-degree increments, or in Fahrenheit, depending on the indoor unit model and the display mode setting on the remote controller.

3.3.2. For wireless remote controller

▶ To decrease the room temperature:

Press (▼) button (3) to set the desired temperature.
The selected temperature is displayed (3).

- Each time you press the button, the temperature value decreases by 1 °C.

▶ To increase the room temperature:

Press (▲) button (3) to set the desired temperature.
The selected temperature is displayed (3).

- Each time you press the button, the temperature value decreases by 1 °C.

- Available temperature ranges are as follows:

Cooling/Drying: 19 - 30 °C
Heating: 17 - 28 °C
Automatic: 19 - 28 °C

- The display flashes either 8 °C - 39 °C to inform you if the room temperature is lower or higher than the displayed temperature.

3.4. Fan speed setting

3.4.1. For wired remote controller

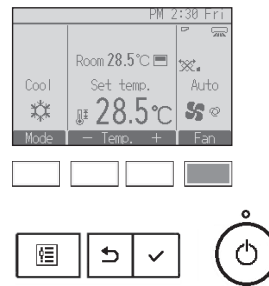

Press the [F4] button to go through the fan speeds in the following order.

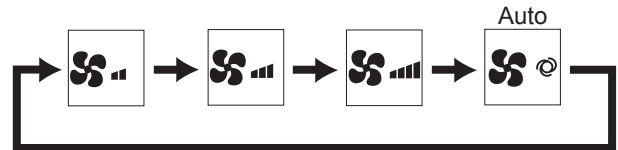

3.4.2. For wireless remote controller

- Press (4) button to select a desired fan speed.

- Each time you press the button, available options change with the display (4) on the remote controller, as shown below.

Fan speed	Remote controller display			
	Low	Medium	High	Auto
3-stage	(3 blades) ↓ → (4 blades)	(4 blades) ↓ → (5 blades)	(5 blades) ↓ → (Auto)	(Auto)

Notes:

- In the following cases, the actual fan speed generated by the unit will differ from the speed shown the remote controller display.
 1. While the display is in "STAND BY" or "DEFROST" states.
 2. When the temperature of the heat exchanger is low in the heating mode. (e.g. immediately after heating operation starts)
 3. In HEAT mode, when room temperature is higher than the temperature setting.
 4. In Cool mode, when room temperature is lower than the temperature setting.
 5. When the unit is in DRY mode.

3. Operation

3.5. Ventilation (For wired remote controller)

3.5.1. Navigating through the Main menu

<Accessing the Main menu>



Press the [MENU] button.
The Main menu will appear.

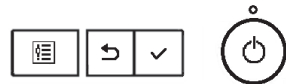

<Item selection>

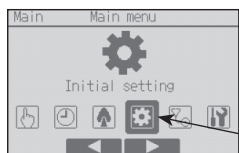

Press [F2] to move the cursor left.
Press [F3] to move the cursor right.

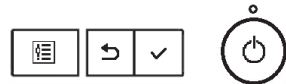

3.5.2. Vane-Vent. (Lossnay)

<Accessing the menu>



Select "Operation" from the Main menu,
and press the [SELECT] button.

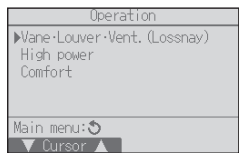
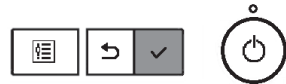

Select "Vane-Louver-Vent. (Lossnay)"
from the Operation menu, and press the
[SELECT] button.



<Vent. setting>

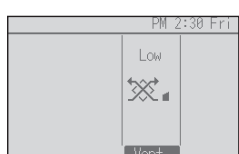

Each pressing of the [F3] button
cycles through the following ventilation
settings.

* Settable only when LOSSNAY
unit is connected.



• The fan on some models of
indoor units may be interlocked
with certain models of ventilation
units.

<Returning to the Operation menu>

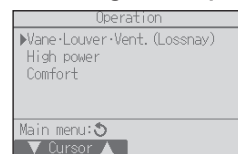

Press the [RETURN] button to go back
to the Operation menu.



3.6. Ventilation (For wireless remote controller)

- The ventilator will automatically operate when the indoor unit turns on.
- No indication on the wireless remote controller.

4. Timer

- Timer functions are different by each remote controller.
- For details on how to operate the remote controller, refer to the appropriate operation manual included with each remote controller.

5. Emergency Operation for Wireless Remote-controller (SEZ-M-DAL2 series)

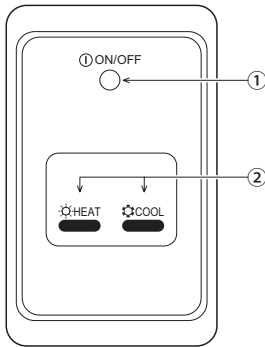

- ① **ON/OFF lamp** (lit when unit is operating; unlit when unit is not operating)
- ② **Emergency operation**
In cases where the remote control unit does not operate properly, use either the ☀️ COOL or ❄️ HEAT button on the wireless remote control signal receiver to toggle the unit on or off. On cooler only units, pushing the ❄️ HEAT button toggles the fan on and off.

Pressing the ☀️ COOL or ❄️ HEAT button selects the following settings.

Operation mode	COOL	HEAT
Preset temperature	24 °C/75 °F	24 °C/75 °F
Fan speed	High	High

6. Care and Cleaning

► Cleaning the filters

- Clean the filters using a vacuum cleaner. If you do not have a vacuum cleaner, tap the filters against a solid object to knock off dirt and dust.
- If the filters are especially dirty, wash them in lukewarm water. Take care to rinse off any detergent thoroughly and allow the filters to dry completely before putting them back into the unit.

⚠️ Caution:

- Do not dry the filters in direct sunlight or by using a heat source, such as an electric heater: this may warp them.
- Do not wash the filters in hot water (above 50°C), as this may warp them.
- Make sure that the air filters are always installed. Operating the unit without air filters can cause malfunction.

⚠️ Caution:

- Before you start cleaning, stop operation and turn OFF the power supply.
- Indoor units are equipped with filters to remove the dust of sucked-in air. Clean the filters following the procedures below.

► Filter removal

⚠️ Caution:



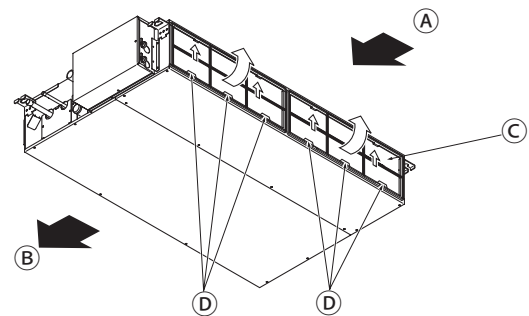



- In removing the filter, precautions must be taken to protect your eyes from dust. Also, if you have to climb up on a stool to do the job, be careful not to fall.
- When the filter is removed, do not touch the metallic parts inside the indoor unit, otherwise injury may result.



- While lifting the filter knob, pull it.

(A) Air intake (B) Air outlet (C) Filter (D) Knob

7. Trouble Shooting

Having trouble?	Here is the solution. (Unit is operating normally.)
Air conditioner does not heat or cool well.	<ul style="list-style-type: none"> ■ Clean the filter. (Airflow is reduced when the filter is dirty or clogged.) ■ Check the temperature adjustment and adjust the set temperature. ■ Make sure that there is plenty of space around the outdoor unit. Is the indoor unit air intake or outlet blocked? ■ Has a door or window been left open?
When heating operation starts, warm air does not blow from the indoor unit soon.	<ul style="list-style-type: none"> ■ Warm air does not blow until the indoor unit has sufficiently warmed up.
During heating mode, the air conditioner stops before the set room temperature is reached.	<ul style="list-style-type: none"> ■ When the outdoor temperature is low and the humidity is high, frost may form on the outdoor unit. If this occurs, the outdoor unit performs a defrosting operation. Normal operation should begin after approximately 10 minutes.
Airflow direction changes during operation or airflow direction cannot be set.	<ul style="list-style-type: none"> ■ During heating mode, the vanes automatically move to the horizontal airflow direction when the airflow temperature is low or during defrosting mode.
When the airflow direction is changed, the vanes always move up and down past the set position before finally stopping at the position.	<ul style="list-style-type: none"> ■ When the airflow direction is changed, the vanes move to the set position after detecting the base position.
A flowing water sound or occasional hissing sound is heard.	<ul style="list-style-type: none"> ■ These sounds can be heard when refrigerant is flowing in the air conditioner or when the refrigerant flow is changing.
A cracking or creaking sound is heard.	<ul style="list-style-type: none"> ■ These sounds can be heard when parts rub against each due to expansion and contraction from temperature changes.
The room has an unpleasant odor.	<ul style="list-style-type: none"> ■ The indoor unit draws in air that contains gases produced from the walls, carpeting, and furniture as well as odors trapped in clothing, and then blows this air back into the room.
A white mist or vapor is emitted from the indoor unit.	<ul style="list-style-type: none"> ■ If the indoor temperature and the humidity are high, this condition may occur when operation starts. ■ During defrosting mode, cool airflow may blow down and appear like a mist.
Water or vapor is emitted from the outdoor unit.	<ul style="list-style-type: none"> ■ During cooling mode, water may form and drip from the cool pipes and joints. ■ During heating mode, water may form and drip from the heat exchanger. ■ During defrosting mode, water on the heat exchanger evaporates and water vapor may be emitted.
"  appears in the remote controller display.	<ul style="list-style-type: none"> ■ During central control, " appears in the remote controller display and air conditioner operation cannot be started or stopped using the remote controller.
When restarting the air conditioner soon after stopping it, it does not operate even though the ON/OFF button is pressed.	<ul style="list-style-type: none"> ■ Wait approximately three minutes. ■ (Operation has stopped to protect the air conditioner.)
Air conditioner operates without the ON/OFF button being pressed.	<ul style="list-style-type: none"> ■ Is the on timer set? Press the ON/OFF button to stop operation. ■ Is the air conditioner connected to a central remote controller? Consult the concerned people who control the air conditioner. ■ Does " appear in the remote controller display? Consult the concerned people who control the air conditioner. ■ Has the auto recovery feature from power failures been set? Press the ON/OFF button to stop operation.
Air conditioner stops without the ON/OFF button being pressed.	<ul style="list-style-type: none"> ■ Is the off timer set? Press the ON/OFF button to restart operation. ■ Is the air conditioner connected to a central remote controller? Consult the concerned people who control the air conditioner. ■ Does " appear in the remote controller display? Consult the concerned people who control the air conditioner.
Remote controller timer operation cannot be set.	<ul style="list-style-type: none"> ■ Are timer settings invalid? If the timer can be set,  or  appears in the remote controller display.
"Please wait" appears in the remote controller display.	<ul style="list-style-type: none"> ■ The initial settings are being performed. Wait approximately 3 minutes.
An error code appears in the remote controller display.	<ul style="list-style-type: none"> ■ The protection devices have operated to protect the air conditioner. ■ Do not attempt to repair this equipment by yourself. Turn off the power switch immediately and consult your dealer. Be sure to provide the dealer with the model name and information that appeared in the remote controller display.
Draining water or motor rotation sound is heard.	<ul style="list-style-type: none"> ■ When cooling operation stops, the drain pump operates and then stops. Wait approximately 3 minutes.
The vanes do not move or the indoor unit does not respond to input from the wireless remote controller.	<ul style="list-style-type: none"> ■ The junction wire connectors of the vane motor and signal receiver may not be connected correctly. Have an installer check the connections. (The colors of the male and female sections of the junction wire connectors must match.)

7. Trouble Shooting

Having trouble?	Here is the solution. (Unit is operating normally.)												
Noise is louder than specifications.	<p>■ The indoor operation sound level is affected by the acoustics of the particular room as shown in the following table and will be higher than the noise specification, which was measured in an echo-free room.</p> <table border="1"> <thead> <tr> <th></th> <th>High sound-absorbing rooms</th> <th>Normal rooms</th> <th>Low sound-absorbing rooms</th> </tr> </thead> <tbody> <tr> <td>Location examples</td> <td>Broadcasting studio, music room, etc.</td> <td>Reception room, hotel lobby, etc.</td> <td>Office, hotel room</td> </tr> <tr> <td>Noise levels</td> <td>3 to 7 dB</td> <td>6 to 10 dB</td> <td>9 to 13 dB</td> </tr> </tbody> </table>		High sound-absorbing rooms	Normal rooms	Low sound-absorbing rooms	Location examples	Broadcasting studio, music room, etc.	Reception room, hotel lobby, etc.	Office, hotel room	Noise levels	3 to 7 dB	6 to 10 dB	9 to 13 dB
	High sound-absorbing rooms	Normal rooms	Low sound-absorbing rooms										
Location examples	Broadcasting studio, music room, etc.	Reception room, hotel lobby, etc.	Office, hotel room										
Noise levels	3 to 7 dB	6 to 10 dB	9 to 13 dB										
Nothing appears in the wireless remote controller display, the display is faint, or signals are not received by the indoor unit unless the remote controller is close.	<p>■ The batteries are low. Replace the batteries and press the Reset button.</p> <p>■ If nothing appears even after the batteries are replaced, make sure that the batteries are installed in the correct directions (+, -).</p>												
After battery installation/replacement of remote controller, part of function cannot be used.	<p>■ Please check that the clock setting is completed. If clock setting is not done, please complete.</p>												
The operation lamp near the receiver for the wireless remote controller on the indoor unit is flashing.	<p>■ The self diagnosis function has operated to protect the air conditioner.</p> <p>■ Do not attempt to repair this equipment by yourself. Turn off the power switch immediately and consult your dealer. Be sure to provide the dealer with the model name.</p>												
The wireless remote controller does not operate (the indoor unit beeps 4 times).	<p>■ Switch the auto mode setting to the AUTO (single set point) mode or AUTO (dual set point) mode. For details, refer to the included Notice (A5 sheet) or the Installation Manual.</p>												
The indoor unit which is not operating becomes warm and a sound, similar to water flowing, is heard from the unit.	<p>■ A small amount of refrigerant continues to flow into the indoor unit even though it is not operating.</p>												

8. Installation, relocation and inspection

Installation place

Avoid installing the air conditioner in the following places.

- Where flammable gas could leak.

⚠ Caution:

Do not install the unit where flammable gas could leak. If gas leaks and collects around the unit, it may cause an explosion.

- Where there is much machine oil.
- Salty place such as the seaside.
- Where sulfide gas is generated such as a hot spring.
- Where there is oil splashing or much oily smoke.

⚠ Warning:

If the air conditioner operates but does not cool or heat (depending on model) the room, consult your dealer since there may be a refrigerant leak. Be sure to ask the service representative whether there is refrigerant leakage or not when repairs are carried out. The refrigerant charged in the air conditioner is safe. Refrigerant normally does not leak, however, if refrigerant gas leaks indoors, and comes into contact with the fire of a fan heater, space heater, stove, etc., harmful substances will be generated.

Electrical work

- Provide an exclusive circuit for power supply of the air conditioner.
- Be sure to observe the breaker capacity.

⚠ Warning:

- The customer should not install this unit. If the unit is installed incorrectly, fire, electric shock, injury due to a falling unit, water leakage, etc. may result.
- Do not connect using branched outlet or an extension cord, and do not attach many loads to one electric outlet. A fire or electric shock may result from poor contact, poor insulation, exceeding the permissible current, etc. Consult your dealer.

⚠ Caution:

- **Apply grounding**
Do not connect a grounding wire to a gas pipe, water pipe, lightning rod or ground wire of a telephone.
If a grounding is incorrect, it may cause an electric shock.
- Install an earth leakage breaker depending on the place where the air conditioner is to be installed (humid place, etc.).
If the earth leakage breaker is not installed, it may cause an electric shock.

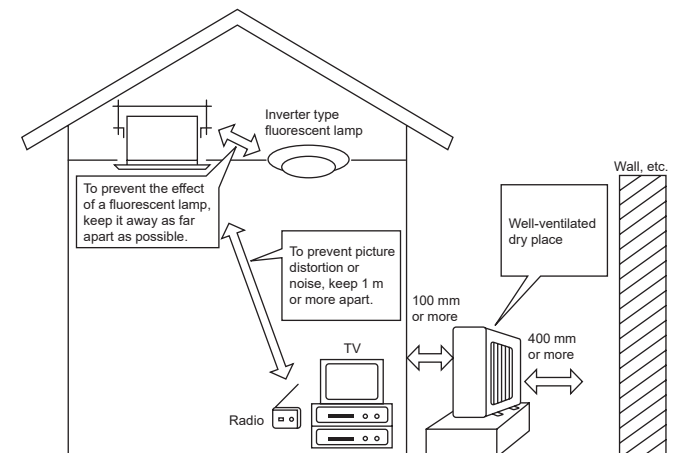

8. Installation, relocation and inspection

Inspection and maintenance

- When the air conditioner is used for several seasons, the capacity may be lowered due to dirt inside the unit.
- Depending upon the conditions of use, an odor may be generated or dirt, dust, etc. may prevent proper drainage.
- It is recommended to apply inspection and maintenance (charged) by a specialist in addition to normal maintenance. Consult your dealer.

Also consider operation sound

- Do not put an object around the air outlet of the outdoor unit. It may cause lowering of capacity or increase operating sound.
- If abnormal sound is heard during operation, consult your dealer.

Relocation

- When the air conditioner is to be removed or reinstalled because of rebuilding, moving, etc., special techniques and work are required.

Warning:

Repair or relocation should not be done by the customer.

If this is done incorrectly, it may cause a fire, electric shock, injury by dropping of the unit, water leakage, etc. Consult your dealer.

Disposal

- To dispose of this product, consult your dealer.

If you have any question, consult your dealer.

9. Specifications

Model		SEZ-M25DA(L)2	SEZ-M35DA(L)2	SEZ-M50DA(L)2	SEZ-M60DA(L)2	SEZ-M71DA(L)2
Power source		~N, 230V, 50Hz/220-230V, 60Hz				
Input (Indoor only)	kW	0.043	0.047	0.077	0.084	0.102
Current (Indoor only)	A	0.44	0.46	0.64	0.67	0.80
Airflow (Lo-Mid-Hi)	CMM	5.5-7-9	7-9-11	10-12.5-15	12-15-18	12-16-20
Ext. static pressure	Pa	5/25/35/50	5/25/35/50	5/25/35/50	5/25/35/50	5/25/35/50
Noise level (Lo-Mid-Hi)	dB	23-26-30	23-27-31	30-34-37	30-34-38	30-35-40
Dimension (H×W×D)	mm	200×790×700	200×990×700	200×990×700	200×1190×700	200×1190×700
Weight	kg	18	22	22	25.5	25.5

Notes: 1. Specifications subject to change without notice.

2. The external static pressure is set to 25 Pa at factory shipment.

Product Information

A Model	B Cooling Capacity (kW)		E Heating Capacity (kW)	F Total electric power input (kW) P _{elec}	G Sound power level (per speed setting, if applicable) (dBA) L _{WA}			
	C Sensible P _{rated,c}	D Latent P _{rated,c}	P _{rated,h}					
SEZ-M25DA2	2.05	0.45	2.90	0.043	50	48	46	-
SEZ-M35DA2	2.73	0.77	4.20	0.047	51	48	46	-
SEZ-M50DA2	3.80	1.20	6.00	0.077	57	55	53	-
SEZ-M60DA2	4.58	1.52	7.40	0.084	58	57	55	-
SEZ-M71DA2	5.25	1.85	8.00	0.102	60	58	56	-
SEZ-M25DAL2	2.05	0.45	2.90	0.043	50	48	46	-
SEZ-M35DAL2	2.73	0.77	4.20	0.047	51	48	46	-
SEZ-M50DAL2	3.80	1.20	6.00	0.077	57	55	53	-
SEZ-M60DAL2	4.58	1.52	7.40	0.084	58	57	55	-
SEZ-M71DAL2	5.25	1.85	8.00	0.102	60	58	56	-

Note: _____

Rating condition

Cooling - Indoor: 27°C DB, 19°C WB
 Outdoor: 35°C DB, 24°C WB
 Heating - Indoor: 20°C DB, 15°C WB
 Outdoor: 7°C DB, 6°C WB

Recycle

Your MITSUBISHI ELECTRIC product is designed and manufactured with high quality materials and components which can be recycled and reused. Electrical and electronic equipment, at their end-of-life, should be disposed of separately from your household waste. Please, dispose of this equipment at your local community waste collection/ recycling center. In the European Union there are separate collection systems for used electrical and electronic product. Please, help us to conserve the environment we live in!

	Deutsch	Български	Eesti
	Français	Polski	Latviski
	Nederlands	Malti	Lietuviškai
	Español	Suomi	Hrvatski
	Italiano	Čeština	Norsk
	Ελληνικά	Slovenčina	Türkçe
	Português	Magyar	русский
	Dansk	Slovenščina	
	Svenska	Română	
A	Modell	Модел	Mudel
	modèle	Model	Modelis
	model	Mudell	Modelis
	modelo	Malli	Model
	modello	Model	Modell
	Μοντέλο	Model	Model
	Modelo	Modell	Модель
	Model	Model	
B	Kühlleistung	Охладителна мощност	Jahutusvõimsus
	Puissance frigorifique	Wydajność chłodnicza	Dzesēšanas jauda
	Koelvermogen	Kapacitá tat-ikessih	Vésinimo pajégumas
	Potencia de refrigeración	Jäähdytysteho	Kapacitet hladenja
	Capacità di raffreddamento	Chladicí výkon	Kļolekapacitē
	Ψυκτική ισχύς	Výkon chladenia	Soğutma Kapasitesi
	Potência de arrefecimento	Hűtőteljesítmény	Охлаждающая мощность
	Køledeelse	Zmogljivost hlajenja	
C	Kylkapacitet	Capacitatea de răcire	
	sensibel	за осезаема топлина	tajutav
	sensible	jawna	jūtama
	waarneembaar	sensitiva	juntamojo
	sensible	tuntuva	osietni
	sensibile	citelný	Fornuftig
	αισθητή	citelný	Duyulur
	razoável	érezhető	Явная
D	sensibel	občutljivo	
	kännbar	sensibilă	
	latent	за скрита топлина	latentne
	latente	utajona	latentā
	latent	latenti	slaptojo
	latente	latenti	latentni
	latente	latentní	Latent
	Λανθάνουσα	latentný	Gizli
E	latente	latens	Скрытая
	latent	latentno	
	latent	Capacitate de încălzire	
	Wärmeleistung	Отопительна мощност	Küttevõimsus
	Puissance calorifique	Wydajność grzewcza	Sildīšanas jauda
	Verwarmingsvermogen	Kapacitá tat-tishin	Šildymo pajégumas
	Potencia de calefacción	Lämmitysteho	Kapacitet grijanja
	Capacità di riscaldamento	Topný výkon	Varmekapasitet
Θερμαντική ισχύς	Vykurovací výkon	Isitma Kapasitesi	
Potência de aquecimento	Fűtőteljesítmény	Отопительная мощность	
Varmeydelse	Zmogljivost ogrevanja		
Uppvärmingskapacitet	Capacitate de încălzire		

F	Elektrische Gesamtleistungsaufnahme	Общо консумирана електрическа мощност	Koguelektritarbimine
	Puissance électrique absorbée totale	Saġkowity pobór mocy elektrycznej	Korpeġa elektriskā ieejas jauda
	Totaal elektrisch ingangsvermogen	Total tal-input tal-enerġija elettrika	Bendra elektrinė vartojamoji galia
	Potencia eléctrica total utilizada	Sähkön kokonaisottoheho	Ukupan utrošak električne energije
	Potenza elettrica assorbita totale	Celkový elektrický příkon	Total elektrisk strøminngang
	Συνολική ηλεκτρική ισχύς εισόδου	Celkový elektrický příkon	Toplam elektrik gücü girişi
	Potência elétrica de entrada total	Teljes villamosenergia-bevitel	Суммарная подводимая электрическая мощность
	Samlet elektrisk effektoptag	Skupna vhodna električna moč	
	Total tillförd elektrisk effekt	Putere electrică de intrare totală	
	G	Schalleistungspegel (ggf. je Geschwindigkeitseinstellung)	Ниво на звуковата мощност (за отделните настройки на оборотите, ако е приложимо)
Niveau de puissance acoustique (pour chaque réglage de la vitesse, si disponible)		Poziom mocy akustycznej (w stosownych przypadkach w zależności od ustawienia prędkości)	Akustiskās jaudas līmenis (attiecīgā gadījumā – katram ātruma iestatījumam)
Geluidsvermogensniveau (per snelheid, indien van toepassing)		Livell ta' qawwa tal-ħoss (għal kull veloċità, jekk ikun applikabbli)	Garso galios lygis (kiekvieno spartos nuostačio, jei taikoma)
Nivel de potencia acústica (por velocidad regulada, si procede)		Äänitehaso (tarvittaessa käyntinopeuksittain)	Razina zvučne snage (u svakoj postavki brzine, ako je primjenjivo)
Livello di potenza sonora (per ogni impostazione di velocità, se pertinente)		Hladina akustického výkonu (v příslušných případech pro jednotlivá nastavení rychlosti)	Lydeffektivitā (per hastighetsinnstilling, hvis aktuelt)
Στάθμη ηχητικής ισχύος (ανά ρυθμιζόμενη ταχύτητα, κατά περίπτωση)		Hladina akustického výkonu (v prípade potreby z hladiska nastavenia rýchlosti)	Ses gücü seviyesi (geçerli durumlarda hız ayarına göre)
Nível de potência sonora (por regulação da velocidade, se for caso disso)		Hangteljesítményszint (fordulatszám-beállításonként, ha alkalmazandó)	Уровень звуковой мощности (по настройке скорости, если применимо)
Lydeffektniveau (pr. hastighedsindstilling, hvis relevant)		Nivo zvokovne moči (na nastavljenosti hitrost, če je ustrezno)	
Ljudeffektivitā (per hastighet, om tillämpligt)		Nivelul de putere acustică (per treaptă de viteză, dacă este cazul)	

EC DECLARATION OF CONFORMITY
EG-KONFORMITÄTSEKHLÄRUNG
DECLARATION DE CONFORMITÉ CE
EG-CONFORMITEITSVERKLARING
DECLARACIÓN DE CONFORMIDAD CE
DICHIARAZIONE DI CONFORMITÀ CE

ΔΗΛΩΣΗ ΠΙΣΤΟΤΗΤΑΣ EK
DECLARAÇÃO DE CONFORMIDADE CE
EG-DEKLARATION OM ÖVERENSSTÄMMELSE
EC UYGUNLUK BEYANI
ДЕКЛАРАЦИЯ СООТВЕТСТВИЯ НОРМАМ ЕС
PROHLÁŠENÍ O SHODĚ EU

VYHLÁŠENIE O ZHODE S NORMAMI ES
IZJAVA ES O SKLADNOSTI
EK MEGFELELŐSÉGI NYILATKOZAT
DEKLARACJA ZGODNOŚCI WE
EC IZJAVA O SUKLADNOSTI
ЕС ДЕКЛАРАЦИЯ ЗА СЪОТВЕТСТВИЕ

DECLARAȚIE DE CONFORMITATE CE
EF-OVERENSSTEMMELSESERKLÆRING
EF-SAMSVARSERKLÆRING

MITSUBISHI ELECTRIC CONSUMER PRODUCTS (THAILAND) CO., LTD.
700/406 MOO 7, TAMBON DON HUA ROH, AMPHUR MUANG, CHONBURI 20000, THAILAND
MADE IN THAILAND

hereby declares under its sole responsibility that the air conditioners and heat pumps described below for use in residential, commercial and light-industrial environments:
erklärt hiermit auf seine alleinige Verantwortung, dass die Klimaanlage und Wärmepumpen für das häusliche, kommerzielle und leicht-industrielle Umfeld wie unten beschrieben:
déclare par la présente et sous sa propre responsabilité que les climatiseurs et les pompes à chaleur décrits ci-dessous, destinés à un usage dans des environnements résidentiels, commerciaux et d'industrie légère :
verklaart hierbij onder eigen verantwoordelijkheid dat de voor residentiële, commerciële en licht-industriële omgevingen bestemde airconditioners en warmtepompen zoals onderstaand beschreven:
por la presente declara bajo su única responsabilidad que los acondicionadores de aire y bombas de calor descritas a continuación para su uso en entornos residenciales, comerciales y de industria ligera.
conferma con la presente, sotto la sua esclusiva responsabilità, che i condizionatori d'aria e le pompe di calore descritti di seguito e destinati all'utilizzo in ambienti residenziali, commerciali e semi-industriali:
με το παρόν πιστοποιώ με αποκλειστική της ευθύνη ότι οι τα κλιματιστικά και οι αντλίες θέρμανσης που περιγράφονται παρακάτω για χρήση σε οικιακό, επαγγελματικό και ελαφράς βιομηχανίας περιβάλλοντα:
através da presente declara sob sua única responsabilidade que os aparelhos de ar condicionado e bombas de calor abaixo descritos para uso residencial, comercial e de indústria ligeira:
intyar härmed att luftkonditioneringarna och värmepumparna som beskrivs nedan för användning i bostäder, kommersiella miljöer och lätta industriella miljöer:
ev, ücareet ve hafif sanayi ortamlarında kullanım amaçlı üretilen ve aşağıda açıklanan klima ve ısıtma pompalarıyla ilgili aşağıdaki hususları yalnızca kendi sorumluluğunda beyan eder:
настоящим заявляет и берет на себя исключительную ответственность за то, что кондиционеры и тепловые насосы, описанные ниже и предназначенные для эксплуатации в жилых помещениях, торговых залах и на предприятиях легкой промышленности:
tímto prohlašuje na svou výhradní odpovědnost, že klimatizační jednotky a tepelná čerpadla popsaná níže jsou určena pro provoz v obytných prostorách, obchodních prostorách a prostorách lehkého průmyslu:
týmto na vlastnú zodpovednosť vyhlasuje, že klimatizácie a tepelné čerpadlá uvedené nižšie, ktoré sú určené na použitie v domácnostiach, oblasti obchodu a ľahkého priemyslu:
izjavljva, v skladu z izkjučno odgovornostjo, da so klimatske naprave in toplotne črpalke, opisane spodaj, za uporabo v stanovanjskih, gospodarskih in manjših industrijskih okoljih:
kizárólagos felelőssége tudatában kijelenti, hogy az alábbiakban leírt – lakossági, kereskedelmi és könnyűipari használatra szánt – légkondicionálók és hőszivattyúk:
niniejszym oświadczamy, że klimatyzatory i pompy ciepłe opisane niżej do użytkowania w środowisku mieszkaniowym, komercyjnym lub przemysłu lekkim:
pod punom odgovornostu izjavljuje da klima-uređaji i toplinske pumpe opisani u nastavku, namijenjeni za korištenje u stambenim i poslovnim prostorima i pogonima lake industrije:
с настоящим декларира на своя собствена отговорност, че климатизаторите и термопомпите, са описани по-долу и предназначени за експлоатация в жилищни помещения, търговски халета и предприятия от леката промишленост:
prin prezenta declară pe proprie răspundere că aparatele de aer condiționat și pompele de căldură descrise mai jos pentru utilizare în medii rezidențiale, comerciale și industriale ușoare:
erklærer hermed med eneansvar, at klimaanlæggene og varmepumperne beskrevet nedenfor til brug i beboelsesmiljøer, kommercielle miljøer og lettindustriemiljøer:
erklærer herved på eget ansvar at klimaanleggene og varmepumperne beskrevet nedenfor for bruk i bolig-, kommersielle og lettindustrielle miljøer:

**MITSUBISHI ELECTRIC, SEZ-M25DA*, SEZ-M35DA*, SEZ-M50DA*, SEZ-M60DA*, SEZ-M71DA*,
SEZ-M25DAL*, SEZ-M35DAL*, SEZ-M50DAL*, SEZ-M60DAL*, SEZ-M71DAL***

Note: Its serial number is on the nameplate of the product.
Hinweis: Die Seriennummer befindet sich auf dem Kennschild des Produkts.
Remarque: Le numéro de série de l'appareil se trouve sur la plaque du produit.
Opmerking: het serienummer staat op het naamplaatje van het product.
Nota: El número de serie se encuentra en la placa que contiene el nombre del producto.
Nota: il numero di serie si trova sulla targhetta del prodotto.
Σημείωση: Ο σειριακός του αριθμός βρίσκεται στην πινακίδα ονόματος του προϊόντος.
Nota: o número de série encontra-se na placa que contém o nome do produto.
Obs: Serienumret finns på produktens namnplåt.
Not: Seri numarasi ürünün isim plakasında yer alır.
Примечание: серийный номер указан на паспортной табличке изделия.

Poznámka: Sériové číslo je na typovém štítku výrobku.
Poznámka: Sériové číslo sa nachádza na továrenskcom štítku produktu.
Opomba: Serijska številka je na tablici z imenom izdelka.
Megjegyzés: A sorozatszám a termék adattábláján található.
Uwaga: Numer serijny znajduje się na tabliczce znamionowej produktu.
Napomena: Serijski broj je naznačen na natpisnoj pločici proizvoda.
Забележка: Серийният номер се намира на табелката с данни на продукта.
Notă: Numărul de serie este amplasat pe plăcuța produsului.
Bemærk: Serienumret befinder sig på produktets typeskilt.
Merk: Serienummeret finner du på produktets typeskilt.

Directives
Richtlijnen
Directives
Richtlijnen
Directivas
Direttive
Οδηγίες
Directivas
Direktiv
Direktiver
Директивы

Směrnice
Smernice
Direktive
Irányelvek
Dyrektywy
Direktive
Директиви
Directive
Direktiver
Direktiver

2014/35/EU: Low Voltage
2006/42/EC: Machinery
2014/30/EU: Electromagnetic Compatibility
2011/65/EU: Restriction of Hazardous Substances
2009/125/EC: Energy-related Products (with Regulation No. 206/2012)

UK DECLARATION OF CONFORMITY

mitsubishi electric consumer products (thailand) co., ltd.
700/406 MOO 7, TAMBON DON HUA ROH, AMPHUR MUANG, CHONBURI 20000, THAILAND
MADE IN THAILAND

hereby declares under its sole responsibility that the air conditioners and heat pumps described below for use in residential, commercial and light-industrial environments:

**mitsubishi electric, SEZ-M25DA*, SEZ-M35DA*, SEZ-M50DA*, SEZ-M60DA*, SEZ-M71DA*,
SEZ-M25DAL*, SEZ-M35DAL*, SEZ-M50DAL*, SEZ-M60DAL*, SEZ-M71DAL***

Note: Its serial number is on the nameplate of the product.

Legislation

Electrical Equipment (Safety) Regulations 2016
Supply of Machinery (Safety) Regulations 2008
Electromagnetic Compatibility Regulations 2016
The Restriction of the Use of Certain Hazardous Substances in Electrical and Electronic Equipment Regulations 2012
The Ecodesign for Energy-Related Products and Energy Information (Amendment) (EU Exit) Regulations 2019

<ENGLISH>

English is original. The other languages versions are translation of the original.

⚠ CAUTION

- Refrigerant leakage may cause suffocation. Provide ventilation in accordance with EN378-1.
- Be sure to wrap insulation around the piping. Direct contact with the bare piping may result in burns or frostbite.
- Never put batteries in your mouth for any reason to avoid accidental ingestion.
- Battery ingestion may cause choking and/or poisoning.
- Install the unit on a rigid structure to prevent excessive operation sound or vibration.
- Noise measurement is carried out in accordance with JIS C9612, JIS B8616, ISO 5151(T1), and ISO 13523(T1).

<DEUTSCH>

Das Original ist in Englisch. Die anderen Sprachversionen sind vom Original übersetzt.

⚠ VORSICHT

- Das Auslaufen von Kältemittel kann zu Erstickung führen. Sorgen Sie für Belüftung gemäß der Bestimmung EN378-1.
- Sicherstellen, dass die Rohrführung isoliert ist. Direkter Kontakt mit der blanken Rohrführung kann zu Verbrennungen oder Erfrierung führen.
- Nehmen Sie unter keinen Umständen Batterien in den Mund, um versehentliches Verschlucken zu vermeiden.
- Das Verschlucken von Batterien kann zu Erstickung und/oder Vergiftung führen.
- Installieren Sie das Gerät an einer stabilen Struktur, um übermäßige Betriebsgeräusche oder Vibration zu vermeiden.
- Geräuschmessungen werden gemäß der Bestimmungen JIS C9612, JIS B8616, ISO 5151(T1), und ISO 13523(T1) ausgeführt.

<FRANÇAIS>

L'anglais est l'original. Les versions fournies dans d'autres langues sont des traductions de l'original.

⚠ PRECAUTION

- Une fuite de réfrigérant peut entraîner une asphyxie. Fournissez une ventilation adéquate en accord avec la norme EN378-1.
- Assurez-vous que la tuyauterie est enveloppée d'isolant. Un contact direct avec la tuyauterie nue peut entraîner des brûlures ou des engelures.
- Ne mettez jamais des piles dans la bouche pour quelque raison que ce soit pour éviter de les avaler par accident.
- Le fait d'ingérer des piles peut entraîner un étouffement et/ou un empoisonnement.
- Installez l'unité sur une structure rigide pour prévenir un bruit de fonctionnement et une vibration excessifs.
- Les mesures de niveau sonore ont été effectuées en accord avec les normes JIS C9612, JIS B8616, ISO 5151(T1) et ISO 13523(T1).

<NEDERLANDS>

Het Engels is het origineel. De andere taalversies zijn vertalingen van het origineel.

⚠ VOORZICHTIG

- Het lekken van koelvloeistof kan verstikking veroorzaken. Zorg voor ventilatie in overeenstemming met EN378-1.
- isoleer de leidingen met isolatiemateriaal. Direct contact met de onbedekte leidingen kan leiden tot brandwonden of bevriezing.
- Stop nooit batterijen in uw mond om inslikking te voorkomen.
- Het inslikken van batterijen kan verstikking of vergiftiging veroorzaken.
- Installeer het apparaat op een stabiele structuur om overmatig lawaai of trillingen te voorkomen.
- Geluidsmetingen worden uitgevoerd in overeenstemming met JIS C9612, JIS B8616, ISO 5151(T1), en ISO 13523(T1).

<ESPAÑOL>

El idioma original del documento es el inglés. Las versiones en los demás idiomas son traducciones del original.

⚠ CUIDADO

- Las pérdidas de refrigerante pueden causar asfixia. Se debe proporcionar la ventilación determinada en EN378-1.
- Asegúrese de colocar el aislante alrededor de las tuberías. El contacto directo con la tubería puede ocasionar quemaduras o congelación.
- Para evitar una ingestión accidental, no coloque las pilas en su boca bajo ningún concepto.
- La ingestión de las pilas puede causar asfixia y/o envenenamiento.
- Coloque la unidad en una estructura rígida para evitar que se produzcan sonidos o vibraciones excesivos debidos a su funcionamiento.
- La medición de los ruidos se lleva a cabo de acuerdo con JIS C9612, JIS B8616, ISO 5151(T1) y ISO 13523(T1).

<ITALIANO>

Il testo originale è redatto in lingua Inglese. Le altre versioni linguistiche rappresentano traduzioni dell'originale.

⚠ ATTENZIONE

- Perdite di refrigerante possono causare asfissia. Prevedere un ventilazione adeguata in conformità alla norma EN378-1.
- Accertarsi di applicare materiale isolante intorno alle tubature. Il contatto diretto con le tubature non schermate può provocare ustioni o congelamento.
- Non introdurre in nessun caso le batterie nella bocca onde evitare ingestioni accidentali.
- L'ingestione delle batterie può provocare soffocamento e/o avvelenamento.
- Installare l'unità su di una struttura rigida in modo da evitare rumore o vibrazioni eccessivi durante il funzionamento.
- La misurazione del rumore viene effettuata in conformità agli standard JIS C9612, JIS B8616, ISO 5151(T1) e ISO 13523(T1).

<ΕΛΛΗΝΙΚΑ>

Η γλώσσα του πρωτοτύπου είναι η αγγλική. Οι εκδόσεις άλλων γλωσσών είναι μεταφράσεις του πρωτοτύπου.

⚠ ΠΡΟΣΟΧΗ

- Η διαρροή του ψυκτικού ενδέχεται να προκαλέσει ασφυξία. Φροντίστε για τον εξαερισμό σύμφωνα με το EN378-1.
- Βεβαιωθείτε ότι τυλίξατε με μονωτικό υλικό τη σωλήνωση. Η απευθείας επαφή με τη γυμνή σωλήνωση ενδέχεται να προκαλέσει εγκαύματα ή κρυοπαγήματα.
- Μην βάζετε ποτέ τις μπαταρίες στο στόμα σας για κανένα λόγο ώστε να αποφύγετε την κατά λάθος κατάποσή τους.
- Η κατάποση μπαταριών ενδέχεται να προκαλέσει πνιγμό και/ή δηλητηρίαση.
- Εγκαταστήστε τη μονάδα σε σταθερή εγκατάσταση ή ώστε να αποφεύγετε τον έντονο ήχο λειτουργίας ή τους κραδασμούς.
- Η μέτρηση θορύβου πραγματοποιήθηκε σύμφωνα με τα JIS C9612, JIS B8616, ISO 5151(T1) και ISO 13523(T1).

<PORTUGUÊS>

O idioma original é o inglês. As versões em outros idiomas são traduções do idioma original.

⚠ CUIDADO

- As fugas de refrigerante podem provocar asfixia. Proporcione ventilação de acordo com a EN378-1.
- Certifique-se de que coloca isolamento em redor da tubagem. O contacto directo com a tubagem pode resultar em queimaduras ou úlceras causadas pelo frio.
- Para evitar uma ingestão accidental, nunca coloque pilhas na boca.
- A ingestão das pilhas pode provocar asfixia e/ou envenenamento.
- Instale a unidade numa estrutura rígida para evitar vibrações ou ruídos excessivos durante o seu funcionamento.
- A medição dos ruídos é efectuada de acordo com a JIS C9612, JIS B8616, ISO 5151(T1), e ISO 13523(T1).

<SVENSKA>

Engelska är originalspråket. De övriga språkversionerna är översättningar av originalet.

⚠ FÖRSIKTIGHET

- Köldmedelsläckage kan leda till kvävning. Tillhandahåll ventilation i enlighet med EN378-1.
- Kom ihåg att linda isolering runt rören. Direktkontakt med bara rör kan leda till brännskador eller köldskador.
- Stoppa aldrig batterier i munnen, de kan sväljas av misstag.
- Om ett batteri sväljs kan det leda till kvävning och/eller förgiftning.
- Montera enheten på ett stadigt underlag för att förhindra höga driftljud och vibrationer.
- Ljudmätningar har utförts i enlighet med JIS C9612, JIS B8616, ISO 5151(T1) och ISO 13523(T1).

<TÜRKÇE>

Aslı İngilizce'dir. Diğer dillerdeki sürümler aslının çevirisidir.

⚠ DİKKAT

- Soğutucu sızıntısı boğulma tehlikesine yol açabilir. EN378-1'e göre havalandırma sağlayın.
- Boruların etrafına izolasyon malzemesi kaplamayı unutmayın. Çıplak boruya doğrudan temas etmek yanmaya ve soğuk ısırmasına neden olabilir.
- Yanlışlıkla yutmamak için pilleri hiçbir nedenle asla ağzınıza sokmayın.
- Pili yutmak boğulmaya ve/veya zehirlenmeye neden olabilir.
- Aşırı çalışma sesinin veya titreşimin oluşmaması için üniteyi sert bir yapı üzerine kurun.
- Ses ölçümü JIS C9612, JIS B8616, ISO 5151(T1), ve ISO 13523(T1) standartlarına göre yapılır.

<РУССКИЙ>

Языком оригинала является английский. Версии на других языках являются переводом оригинала.

⚠ ОСТОРОЖНО

- Утечка хладагента может стать причиной удушья. Обеспечьте вентиляцию в соответствии с EN378-1.
- Обязательно оберните трубы изоляционной обмоткой. Непосредственный контакт с неизолированным трубопроводом может привести к ожогам или обморожению.
- Запрещается класть элементы питания в рот по каким бы то ни было причинам во избежание случайного проглатывания.
- Попадание элемента питания в пищеварительную систему может стать причиной удушья и/или отравления.
- Устанавливайте устройство на жесткую структуру во избежание чрезмерного шума или чрезмерной вибрации во время работы.
- Измерение шума выполняется в соответствии с JIS C9612, JIS B8616, ISO 5151(T1) и ISO 13523(T1).

<ČESKY>

Originálem je angličtina. Ostatní jazykové verze jsou překladem originálu.

⚠ UPOZORNĚNÍ

- Únik chladiva může způsobit udušení. Zajistěte větrání v souladu s normou EN378-1.
- Nezapomeňte okolo potrubí umístit izolaci. Přímý styk s holým potrubím může způsobit popáleninám nebo omrzlinám.
- Nikdy nevkládejte baterie z žádného důvodu do úst, abyste je náhodně neposlkali.
- Spolknutí baterie může způsobit udušení nebo otrávení.
- Jednotku namontujte na tuhou konstrukci, abyste zabránili nadměrné provozní hlučnosti nebo vibracím.
- Měření hlučnosti se provádí v souladu s normami JIS C9612, JIS B8616, ISO 5151(T1) a ISO 13523(T1).

<SLOVENČINA>

Pôvodným jazykom je angličtina. Ostatné jazykové verzie vznikli prekladom z pôvodného jazyka.

⚠ UPOZORNENIE

- Presakovanie chladivacej zmesi môže spôsobiť udusenie. Zabezpečte vetranie v súlade s normou EN378-1.
- Okolo potrubia omotajte izoláciu. Priamy kontakt s neizolovaným potrubím môže viesť k popáleninám alebo omrzlinám.
- Zo žiadneho dôvodu si nevkładajte batérie do úst. Mohli by ste ich náhodne prehltnúť.
- Prehltnutie batérií môže vyvolať dusenie alebo otravu.
- Jednotku umiestnite na pevnú konštrukciu, aby ste predišli nadmernému prevádzkovému huku alebo vibráciám.
- Meranie hľuku sa vykonáva v súlade s normami JIS C9612, JIS B8616, ISO 5151(T1) a ISO 13523(T1).

<SLOVENŠČINA>

Izvirnik je v angleščini. Drugi jezikovne različice so prevodi izvirnika.

⚠ POZOR

- Uhajanje sredstva za hlajenje lahko povzroči zadušitev. Poskrbite za prezračevanje v skladu z EN378-1.
- Cevi ovijte v izolacijo. Neposredni stik z golimi cevmi lahko povzroči opekline ali ozebline.
- Nikoli ne vstavljajte baterij v usta, da s tem preprečite nenamerno zaužitje.
- Zaužitje baterije lahko povzroči dušenje in/ali zastrupitev.
- Enoto namestite na trdno strukturo, da s tem preprečite prekomerni hrup in vibracije med delovanjem.
- Meritve hrupa so izvršene v skladu z JIS C9612, JIS B8616, ISO 5151(T1) in ISO 13523(T1).

<MAGYAR>

Az eredeti szöveg angol nyelven íródott. A más nyelven írt változatok az eredeti szöveg fordításai.

▲ FIGYELMEZTETÉS

- A hűtőközeg szivárgása fulladást okozhat. Gondoskodjon a szellőzésről az EN378-1 szerint.
- Feltétlenül gondoskodjon a csövek szigeteléséről. A fedetlen csövek közvetlen megérintése égési vagy fagyási sérülést okozhat.
- Soha, semmilyen okból ne vegye a szájába az elemeket, nehogy véletlenül lenyelje.
- Az elem lenyelése fulladást és/vagy mérgezést okozhat.
- Az üzem közben fellépő, túlzott mértékű zaj és rezgés elkerülése érdekében az egységet merev szerkezetre kell szerelni.
- A zaj mérése a JIS C9612, JIS B8616, ISO 5151(T1) és ISO 13523(T1) szerint történik.

<POLSKI>

Oryginał jest w języku angielskim. Pozostałe wersje językowe stanowią tłumaczenia oryginału.

▲ PRZESTROGA

- Wyciek czynnika chłodniczego może spowodować uduszenie. Należy zapewnić wentylację zgodnie z normą EN378-1.
- Należy pamiętać o owinięciu instalacji rurą materiałem izolacyjnym. Bezpośredni kontakt z nieosłoniętą instalacją może spowodować oparzenia lub odmrożenia.
- Nigdy pod żadnym pozorem nie wkładaj baterii do ust, mogłoby to spowodować przypadkowe połknięcie.
- Połknięcie baterii może spowodować udławienie i/lub zatrucie.
- Zamontować jednostkę na sztywnej konstrukcji, aby zapobiec nadmiernemu hałasowi lub wibracjom podczas pracy.
- Pomiar hałasu został wykonany zgodnie z normami JIS C9612, JIS B8616, ISO 5151(T1) i ISO 13523(T1).

<HRVATSKI>

Izvornik je na engleskom jeziku. Druge jezične verzije su prijevod izvornika.

▲ OPREZ

- Istjecanje rashladnog sredstva može izazvati gušenje. Osigurajte prozračivanje sukladno normi EN378-1.
- Obvezno omotajte izolaciju oko cijevi. Izravan dodir s golim cijevima može dovesti do opekline ili smrztotina.
- Nikad i ni pod kojim uvjetima ne stavljajte baterije u usta kako ih ne biste slučajno progutali.
- Gutanje baterija može izazvati gušenje i/ili trovanje.
- Uredaj ugradite na čvrstu konstrukciju kako bi se spriječio prejak zvuk ili vibracija pri radu.
- Mjerenje buke obavlja se sukladno normama JIS C9612, JIS B8616, ISO 5151(T1) i ISO 13523(T1).

<БЪЛГАРСКИ>

Оригиналът е на английски език. Версиите на други езици са превод от оригинала.

▲ ВНИМАНИЕ

- Течът на хладилен агент може да причини задушаване. Осигурете вентилация в съответствие с EN378-1.
- Не забравяйте да обвийте тръбите с изолация. Прекият контакт с неизолирани тръби може да доведе до изгаряния или измръзвания.
- Никога не слагайте батерии в устата си по каквато и да било причина, за да избегнете случайно поглъщане.
- Поглъщането на батерии може да причини задавяне и/или отравяне.
- Инсталирайте модула на стабилна подложка, за да предотвратите излишен шум или вибрации вследствие експлоатацията.
- Измерванията на шума се изпълняват в съответствие с JIS C9612, JIS B8616, ISO 5151(T1) и ISO 13523(T1).

<ROMÂNĂ>

Versiunea în limba engleză este originală. Versiunile din celelalte limbi sunt traduceri ale originalului.

▲ ATENȚIE

- Scurgerea agentului frigorific poate provoca sufocarea. Asigurați ventilația în conformitate cu standardul EN378-1.
- Asigurați-vă că izolați țevile. Contactul direct cu țevile neizolate poate duce la arsuri sau degerături.
- Nu introduceți niciodată bateriile în gură pentru a evita ingerarea accidentală.
- Ingerarea bateriilor poate provoca sufocarea și/sau otrăvirea.
- Instalați unitatea pe o structură rigidă pentru a preveni sunetul sau vibrația excesive în timpul funcționării.
- Măsurarea zgomotului este efectuată în conformitate cu standardele JIS C9612, JIS B8616, ISO 5151(T1) și ISO 13523(T1).

<Dansk>

Engelsk er originalsproget. Versionerne på andre sprog er oversættelser af originalversionen.

▲ FORSIGTIG

- Kølemiddellækage kan forårsage kvælning. Sørg for udluftning i overensstemmelse med EN378-1.
- Husk at vikle isolering om rørføringen. Direkte kontakt med uisoleret rørføring kan medføre forbrændinger eller forfrysninger.
- Tag aldrig batterier i munden af nogen årsag for at undgå tilfældig slugning.
- Slugning af batterier kan medføre kvælning og/eller forgiftning.
- Monter enheden på en stiv konstruktion for at undgå meget høje driftslyde eller vibration.
- Støjmåling udføres i overensstemmelse med JIS C9612, JIS B8616, ISO 5151(T1) og ISO 13523(T1).

<Norsk>

Engelsk er originalspråket. De andre språkversjonene er oversettelse av originalen.

▲ Forsiktig

- Kjølemiddellekkasje kan forårsake kvælning. Sørg for ventilasjon i henhold til EN378-1.
- Sikre at du vikler isolasjonen rundt rørene. Direkte kontakt med røret kan føre til forbrenning eller frostbit.
- Batteriene skal aldri plasseres i munnen av noen grunn for å unngå utilsiktet inntak.
- Inntak av batterisyre kan forårsake kvælning og/eller forgiftning.
- Installer enheten på en stødig struktur for å hindre overdreven driftslyd eller vibrasjon.
- Støymåling utføres i henhold til JIS C9612, JIS B8616, ISO 5151(T1) og ISO 13523(T1).

This product is designed and intended for use in the residential, commercial and light-industrial environment.

Please be sure to put the contact address/telephone number on this manual before handing it to the customer.

mitsubishi **ELECTRIC CORPORATION**

HEAD OFFICE: TOKYO BLDG., 2-7-3, MARUNOUCHI, CHIYODA-KU, TOKYO 100-8310, JAPAN